

INSTALLATION SHEET

HVC 150C E-Truck charger (NAM)

This document briefly indicates the main relevant elements for the installation of the HVC charger. It can be used as a basic to determine the requirements for a site. The first page explains the installation for 1 depot charge box. The second page explains the installation for two (2) or three (3) depot charge boxes.

General:

- The electrical installation should be designed and constructed according to local laws, safety and electrical regulations.
- A ground electrode should be installed in the earth close to the first charge box or cabinet, based on local regulations and site design. The ground-resistance must be $\leq 10 \Omega$ (subject to local regulations).
- More detailed information is available in the installation manual.

Electrical installation

Main AC Power supply:

- 1 X power switch 3P: 150 kW
- 3 X fuse 3P: 300 A (no neutral required)
- Option: 1 X Surge Protected Device type 1

Input power cable:

- 1 X AC power cable 3P+PE: 4 X 450 kcmil maximum

Specification:

- Nominal input voltage: $480 V_{AC} \pm 10\%$
- Nominal frequency: $60 \text{ Hz} \pm 1\%$
- Nominal input current: 200 A
- Input power: 174 kVA
- Power Factor ($\cos \Phi$): ≥ 0.95
- 3G connection integrated

Cables between cabinet and charge box:

- Placed in conduit #1:
- 2 X DC power cable: 350 kcmil (maximum)
- Placed in conduit #2:
- 1 X Interlock cable: 2 X 2 X 19 AWG
 - 1 X PE wire: 1 X 6 AWG
 - 4 X communication: 8 X glass fiber

Depot charge box:

- Output voltage range: 150 – 850 V_{DC}
- Maximum output current: 200 A_{DC}
- Maximum output power: 150 kW
- CCS Output charging protocol
- CCS Cable length 3.5 m (optional: 7 m)

Auxiliary input power cable:

- Placed in conduit #2 (cabinet - depot) or in conduit #3 (aux. - depot):
- 1 X AC auxiliary power 1P+N+PE: 3 X 14 AWG

Auxiliary AC power supply (mandatory) per depot charge box:

- Typically combined with Main AC power supply. Can be located in separate place
- 1 X 1P GFCI Class B (30 mA) circuit breaker: 15 A
 - Continuous power consumption: 500 W
 - Inrush current: 48 A < 5 ms
 - Option: 1 X surge protected device type 1

Physical installation

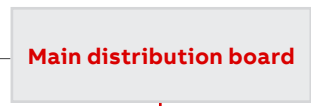

Fast Charge Station

- 1 X HVC-150C
- Dimensions: 2030 x 1170 x 770 mm (H X W X D), Weight: 1340 kg

Placement (two options):

- Concrete foundation block 700 x 1170 X 1300 mm (H X W X D)
- Support frame for an existing floor

- Maximum distance between Fast Charge Station and depot charge box: 150 m

Depot Charge Box

- Dimensions: 800 X 600 X 210 mm (H X W X D), Weight: 65 kg

Placement:

- Wall-mount support
- Optional: Support frame for an existing floor
- Optional: External emergency and start/stop button and external beacon light

INSTALLATION SHEET

HVC 150C E-Truck charger (NAM)

Installation of two or three depot charge boxes:

General:

- The electrical installation should be designed and constructed according to local laws, safety and electrical regulations.
- A ground electrode should be installed in the earth close to the first charge box or cabinet, based on local regulations and site design. The ground-resistance must be $\leq 10 \Omega$ (subject to local regulations).
- More detailed information is available in the installation manual.

Electrical installation

Main AC Power supply:

- 1 X power switch 3P: 150 kW
- 3 X fuse 3P: 300 A (no neutral required)
- Option: 1 X Surge Protected Device type 1

Input power cable:

- 1 X AC power cable 3P+PE: 4 X 450 kcmil maximum

Specification:

- Nominal input voltage: $480 V_{AC} \pm 10\%$
- Nominal frequency: $60 \text{ Hz} \pm 1\%$
- Nominal input current: 200 A
- Input power: 174 kVA
- Power Factor ($\cos \Phi$): ≥ 0.95
- 3G connection integrated

Cables between cabinet and charge box:

- Placed in conduit #1:
- 2 X DC power cable: 350 kcmil (maximum)
- Placed in conduit #2:
- 1 X Interlock cable: 2 X 2 X 19 AWG
 - 1 X PE wire: 1 X 6 AWG
 - 4 X communication: 8 X glass fiber

Depot charge box:

- Output voltage range: 150 – 850 V_{DC}
- Maximum output current: 200 A_{DC}
- Maximum output power: 150 kW
- CCS Output charging protocol
- CCS Cable length 3.5 m (optional: 7 m)

Auxiliary input power cable:

- Placed in conduit #2 (cabinet - depot) or in conduit #3 (aux. - depot):
- 1 X AC auxiliary power 1P+N+PE: 3 X 14 AWG

Auxiliary AC power supply (mandatory) per depot charge box¹:

- Typically combined with Main AC power supply. Can be located in separate place
- 1 X 1P GFCI Class B (30 mA) circuit breaker: 15 A
 - Continuous power consumption: 500 W
 - Inrush current: 48 A < 5 ms
 - Option: 1 X surge protected device type 1

Physical installation

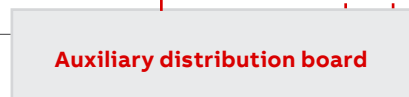
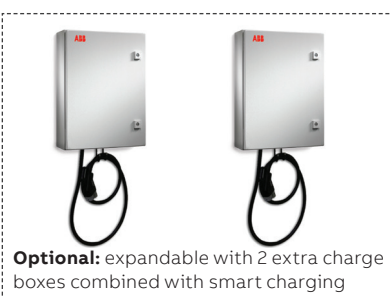
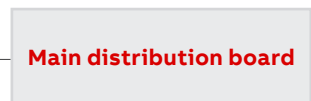

- Maximum distance between Fast Charge Station and charge control set: 150 m
- Maximum distance between depot charge boxes: 30 m

Cables between charge boxes:

- Daisy chained (Box 1 → 2, Box 2 → 3)
Placed in conduit
- 2 X DC power cable: 350 kcmil (maximum)
- Placed in conduit separate from DC cable conduit
- 1 X AC auxiliary power 1P+N+PE: 3 X 14 AWG
 - 1 X Interlock/Monitor cable: 2 X 2 X 19 AWG
 - 1 X Ethernet: 1 X FTP Cat6 / Cat5e
 - 2 X communication: 4 X glass fiber
 - 2 X PE wire: 2 X 6 AWG *
- * refer to grounding scheme

Smart Charging: Smart charging allows for a maximum of 3 depot charge boxes to be connected to one fast charge station. The depot charge boxes are daisy chained and vehicles can be charged sequentially and on a first come first served basis. The maximum distance between 2 depot boxes can be up to 30 m.

¹ refer to configuration options

INSTALLATION SHEET

HVC 150C E-Truck charger (NAM)

Overview of cables coming to depot charge box

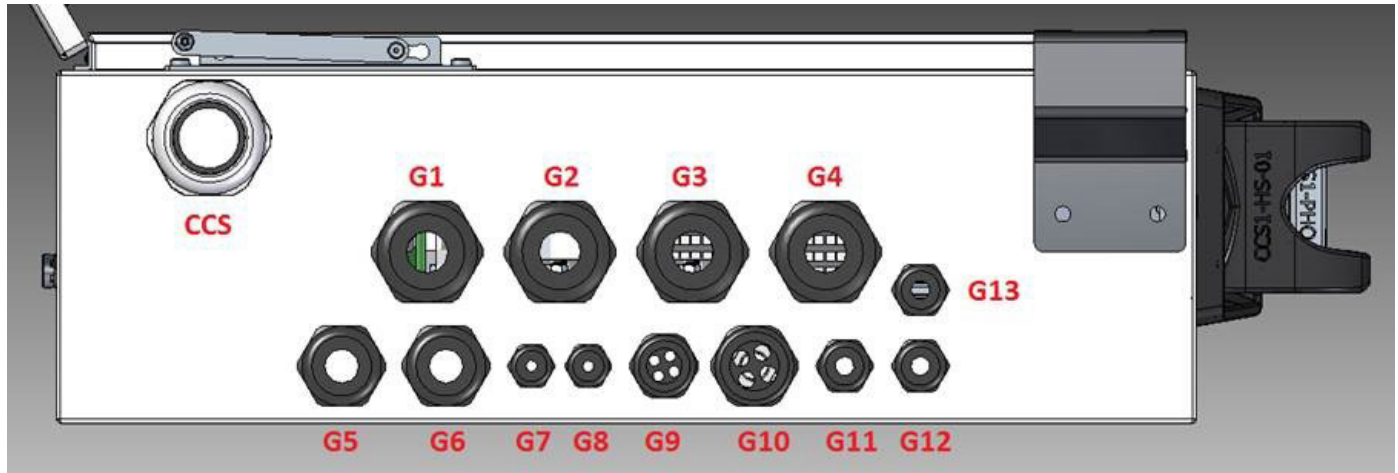

No	Signal	Wire	Gland dimensions	Cable specs	Gland nr
1	Charging cable	CCS1/2	CCS fi 33 - 38 mm	Provided with chargebox	CCS
2	DC+ In	1 X 350 MCM	22 - 32 mm	TF-Kable W-RHH-RHW-2-2000V, W350-1XT, 350 MCM note: 350 MCM with reinforced isolation > 5400 VDC	G3
3	DC- In	1 X 350 MCM	22 - 32 mm	As above	G1
4	DC+ Out	1 X 350 MCM	22 - 32 mm	As above	G4
5	DC- Out	1 X 350 MCM	22 - 32 mm	As above	G2
6	PE	1 X 6 AWG	fi 8-9 mm	OLFLEX 4160900 (Fi-OD: 8.9 mm)	G10
7	PE	1 X 6 AWG	fi 8-9 mm	OLFLEX 4160900 (Fi-OD: 8.9 mm)	G10
8	PE	1 X 2-8 AWG	fi 6-12 mm	OLFLEX 4161100 (2 AWG) (Fi-OD: 11.4 mm)	G11
9	AC input	3 X 14 AWG	fi 6-12 mm	OLFLEX 10019945 Fi-OD: 8.3 mm	G12
10	AC output	3 X 14 AWG	fi 6-12 mm	As above	G13
11	Interlock/Monitor In	2 X 2 X 19 AWG (Shielded Twisted Pair)	fi 8-9 mm	Lapp UniTronic LiYCY(TP) 0066262 Fi-OD = 8.7 mm	G10
12	Interlock/Monitor Out	2 X 2 X 19 AWG (Shielded Twisted Pair)	fi 8-9 mm	As above	G10
13	Ethernet In	Cat6 / Cat5e (Shielded Twisted Pair)	fi 5-10 mm		G7
14	Ethernet Out	Cat6 / Cat5e (Shielded Twisted Pair)	fi 5-10 mm		G8
15	Ext. EMO switch	4 X 20 AWG	fi 5-6 mm	OLFLEX classic 110 H, 4 X 20 AWG/ 10019904 Fi-OD: 5.8 mm	G9
16	Ext. Beacon	4 X 20 AWG	fi 5-6 mm	As above	G9
17	Ext. Start button	2 X 20 AWG	fi 5-6 mm	As above	G9
18	Spare		fi 5-6 mm		G9
19	Fiber-optic In	2 fibers (recommended 4 for spare)*	M32	OM3, pre-fabricated optical fiber	G5
20	Fiber-optic Out	2 fibers (recommended 4 for spare)	M32	OM3, pre-fabricated optical fiber	G6

* 4 fibers (recommended 8 for spare) for connection from HVC to first depot charge

INSTALLATION SHEET

HVC 150C E-Truck charger (NAM)

Distance limitation

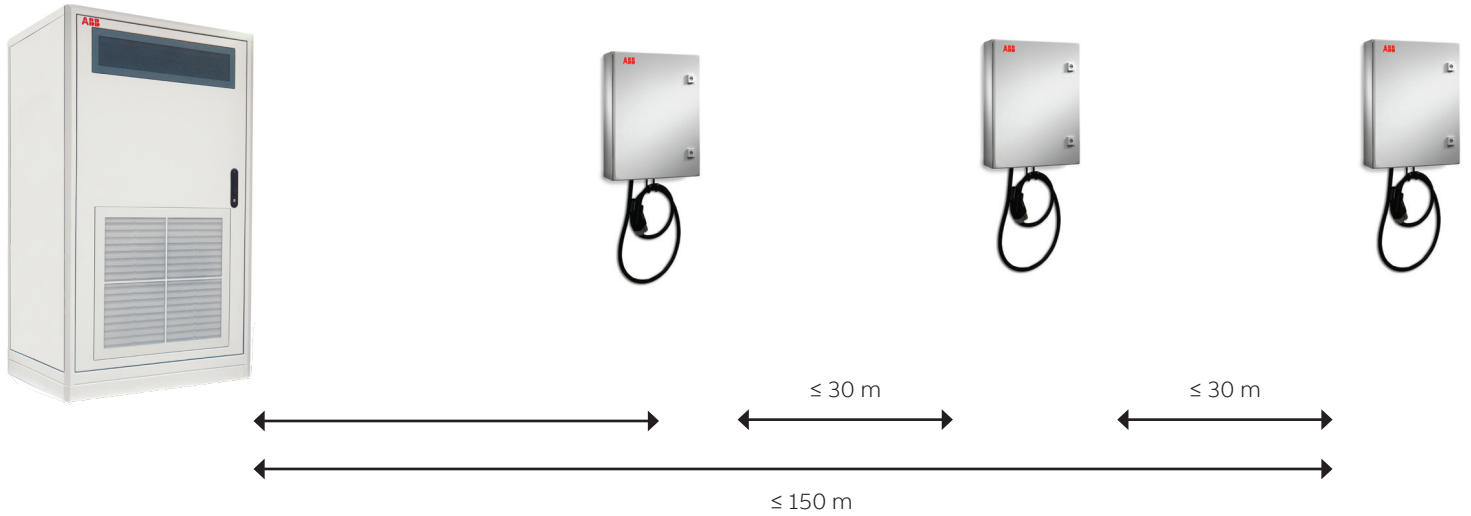

Auxiliary AC power supply configurations

1 - Daisy-chained connection option

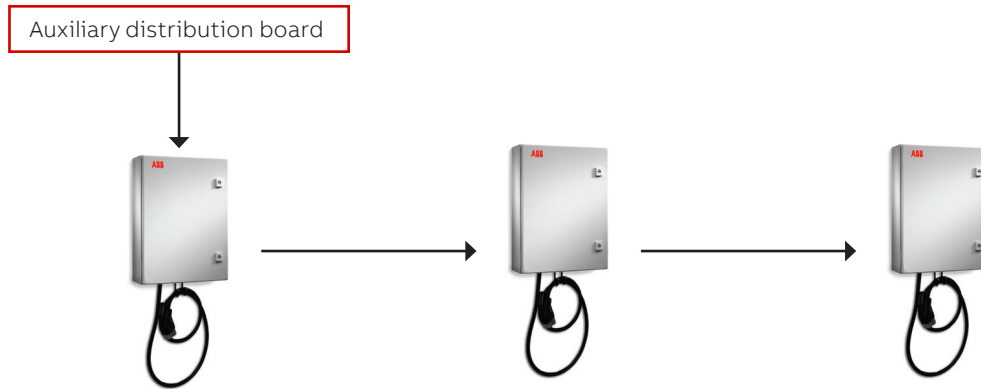

2 - Individual connection option

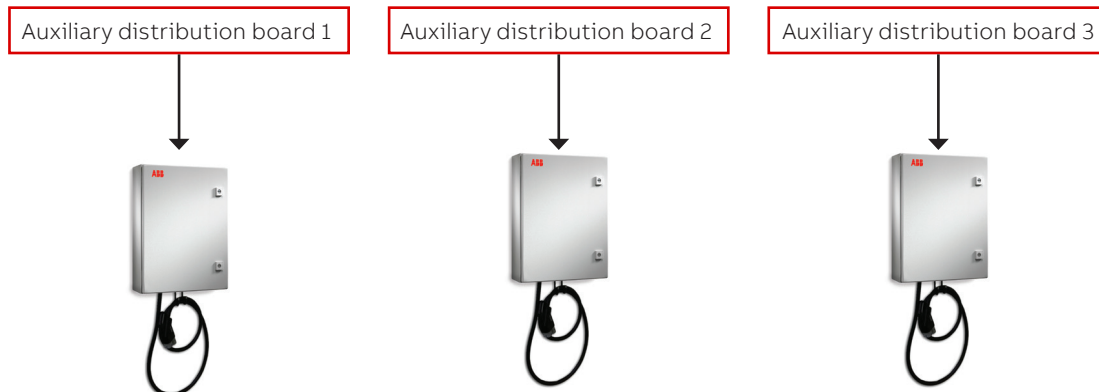

INSTALLATION SHEET

HVC 150C E-Truck charger (NAM)

Proposed grounding scheme

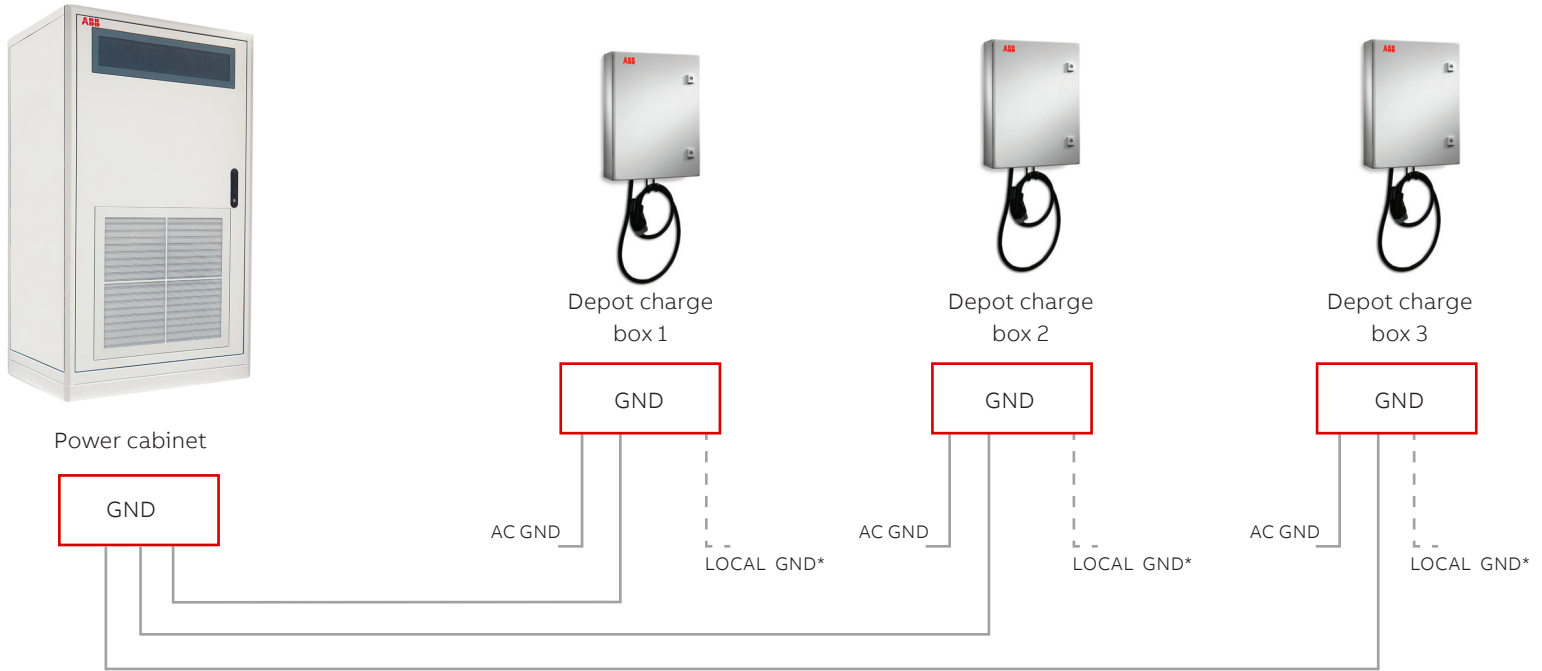

* if available LOCAL GND can be used instead of CABINET GND