

REVISIONS				
ZONE	REV.	DESCRIPTION	DATE	APPROVED
	A	EVCS PRODUCT LINE FOR CUSTOMER REVIEW	11/15/2023	CJ

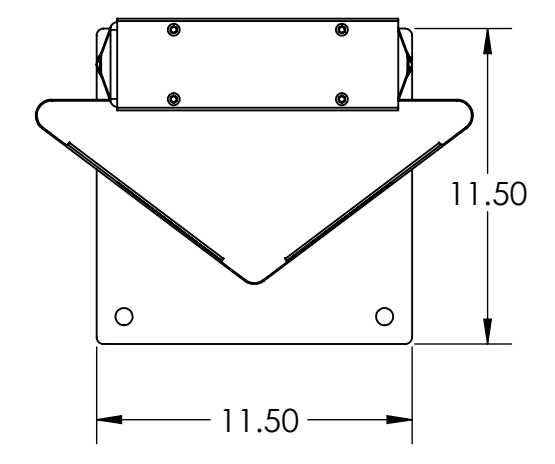

ISO

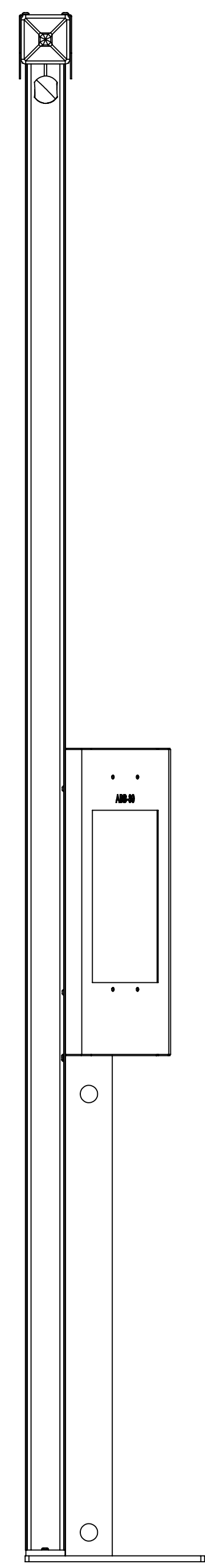
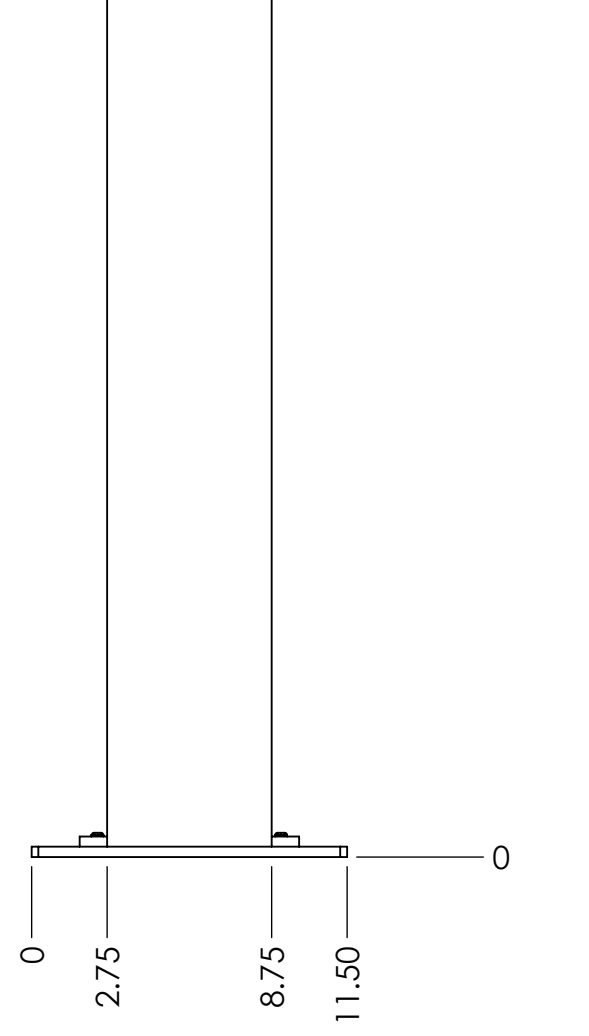
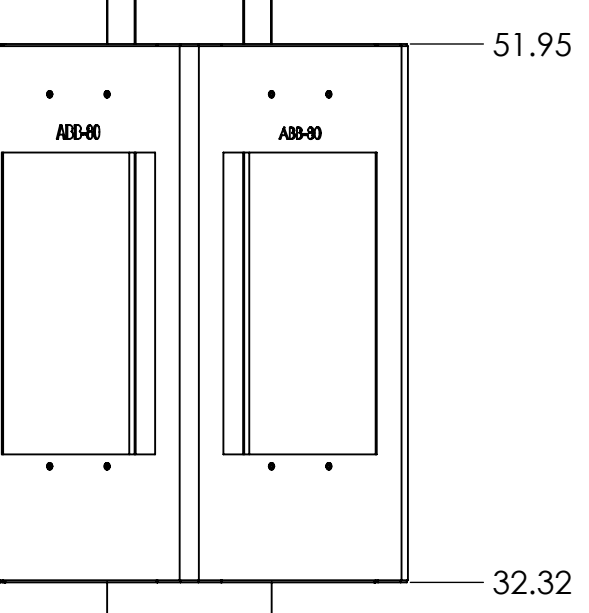
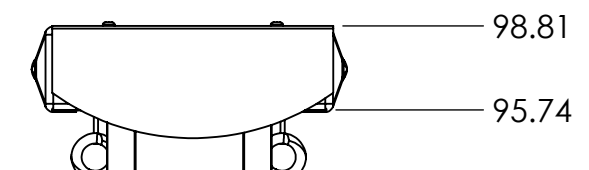

LEFT

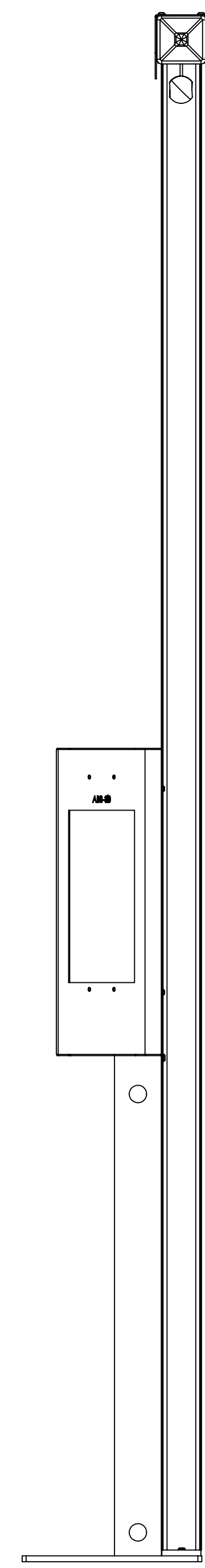

RIGHT

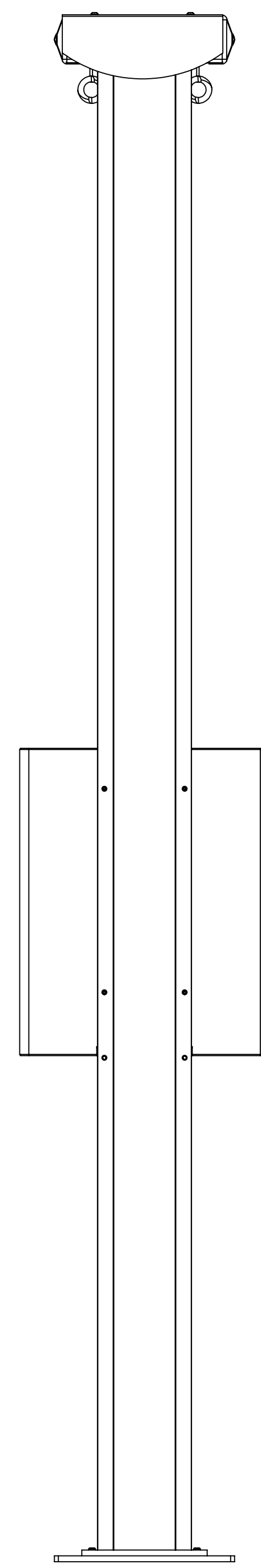

REAR

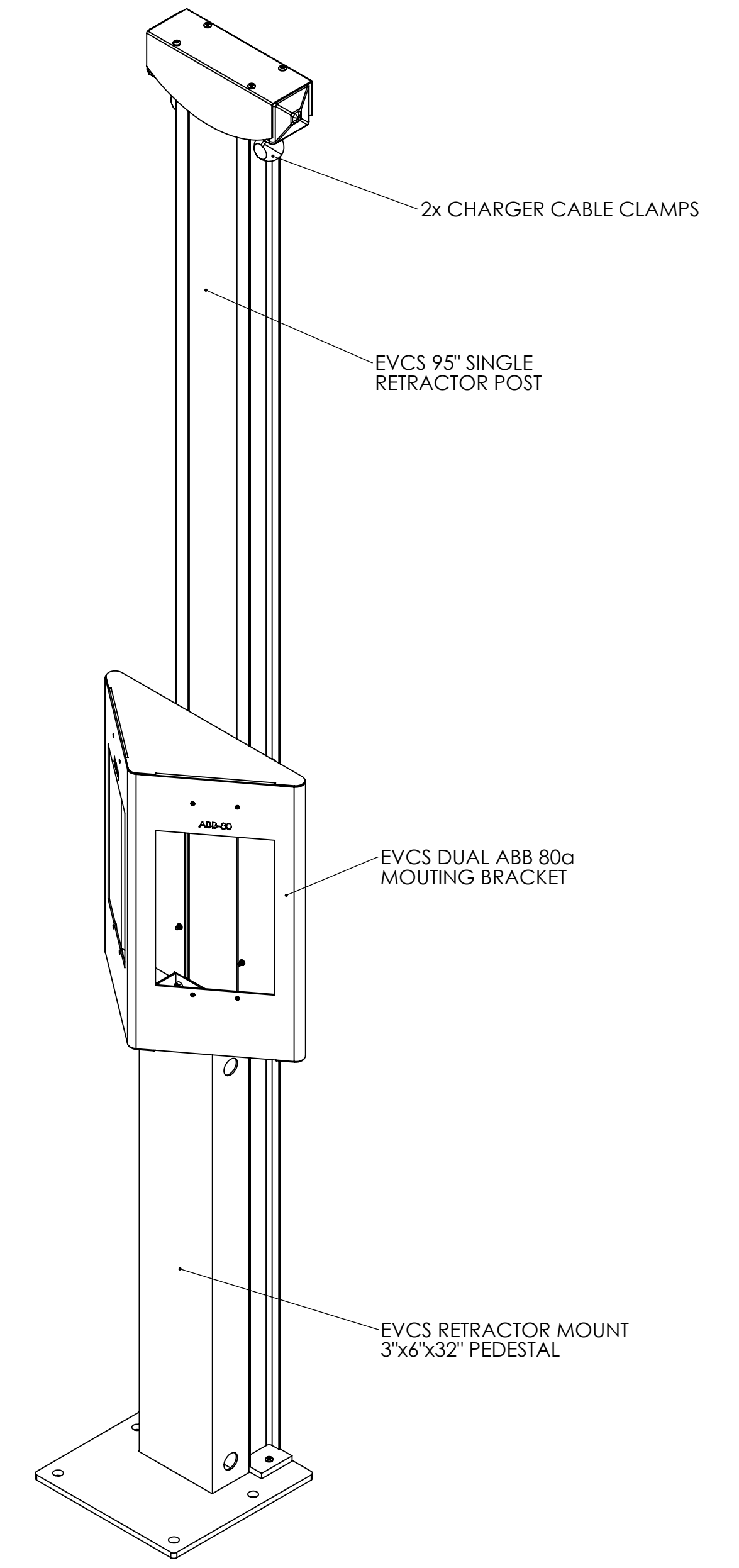

TOP

EVCS - 95" DUAL RETRACTOR / SINGLE ABB 80a MOUNTING BRACKET MODEL

Wednesday, November 15, 2023 9:16:29 AM

PROPRIETARY AND CONFIDENTIAL

MANUFACTURING STANDARDS UNLESS OTHERWISE SPECIFIED: X.X" ± .000" X.XXX" ± .000" ANGLES ± 1°

evCHARGE Solutions

DRAWN	CJ	DATE	11/15/23
CHECKED			
ENG APPR.			
MFG APPR.			
Q.A.			

TITLE: EVCS - 95" DUAL RETRACTOR - DUAL ABB 40-80g MOUNTING BRACKET LAYOUT DETAIL

SIZE DWG. NO. REV: D EVCS-ABB-DR-CR-95-80a A

SCALE: NTS WEIGHT: SHEET 1 OF 1

D CS-ABB-DR-CR-95-80a